

Slide 1

Memory Systems

"...memory is, *per se*, a biological fact – by accident, a psychological fact.... The disorders and maladies of this faculty, when classified and properly interpreted, are no longer to be regarded as a collection of amusing anecdotes of only passing interest. They will be found to be regulated by certain laws which constitute the very basis of memory, and from which its mechanism is easily laid bare."

Th. Ribot, 1882

Slide 2

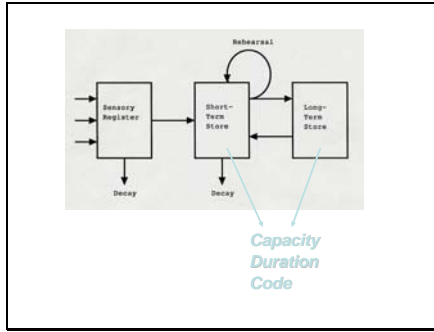

Slide 3

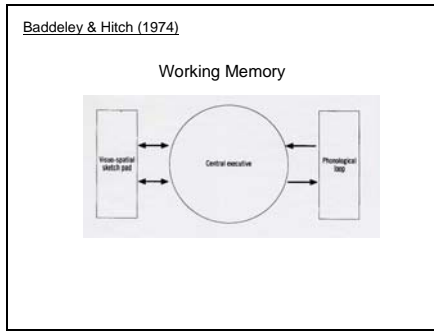

Slide 4

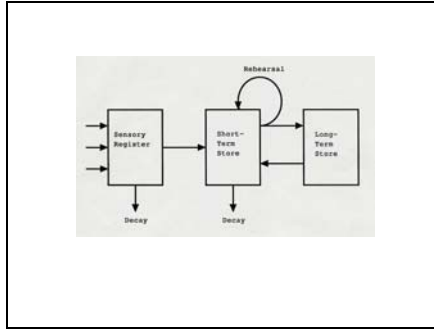

Slide 5

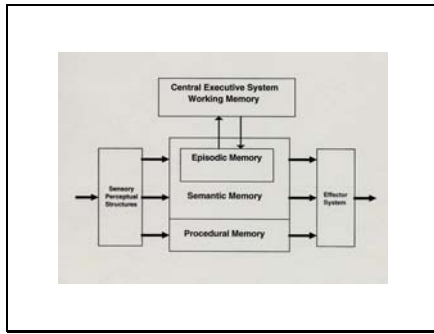

Slide 6

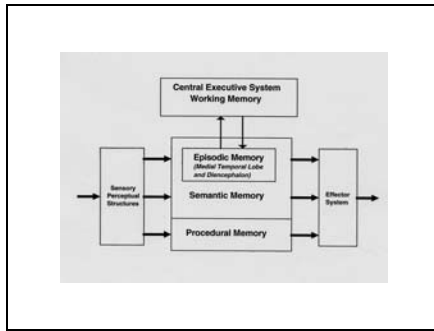

Slide 7

Amnesic Syndrome
A profound long-term memory impairment with a relative preservation of all other intellectual capacities.

Alcoholic Korsakoff's Syndrome
Medial Temporal Lobe Amnesia



Slide 8

Alcoholic Korsakoff's Syndrome

First described by Wernicke & Korsakoff in 1880s.

- *Wernicke-Korsakoff Syndrome*
- *thiamine deficiency + alcohol abuse*

1. Wernicke phase: transient confusional state
2. Korsakoff phase: chronic, severe amnesia
 - *amnesia*
 - *personality changes*
 - *tendency to confabulate*

Slide 9

Medial Temporal Lobe Amnesia

Scoville & Milner (1957): **Patient HM**

- *27 y/o motor winder with seizures since age 10.*
- *given radical bilateral temporal lobectomy*

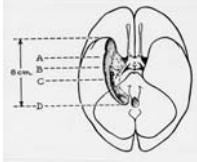

Slide 10

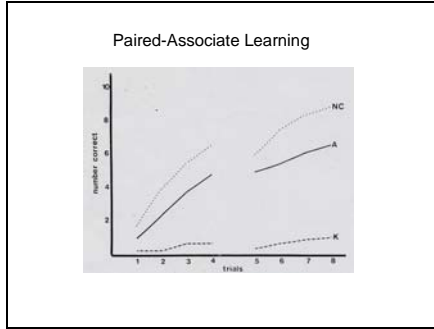

Slide 11

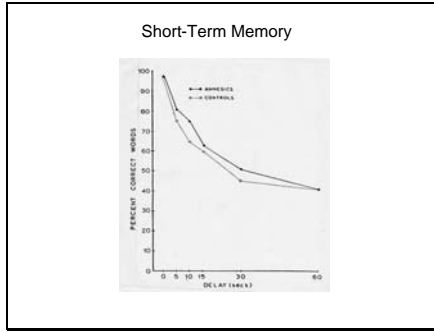

Slide 12

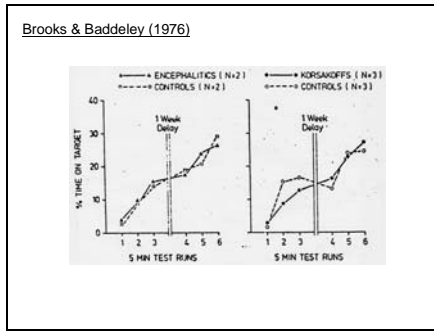

Slide 13

Cohen & Squire (1980)

bedraggle - capricious - grandiose

Slide 14

Cohen & Squire (1980)

bedraggle - capricious - grandiose

Slide 15

Cohen & Squire (1980)

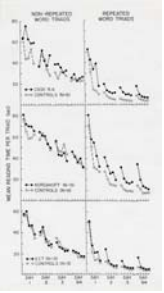

Slide 16

PRIMING
Facilitation of the processing of stimuli due to prior presentation of the same or related stimuli.

Slide 17

PENDULUM
FLAMINGO
AGNOSTIC

Slide 18

_L_MI_G_
_AZ_L_E
_G_O_T_C
_NE_T_A
_E_D_L_M
_S_R_S_O

Slide 19

Vargha-Khadem et al. (1997)

Beth (age 14)
 - born without heartbeat for 7 to 8 minutes
 - sporadic seizures for 2 to 3 days

Jon (age 19)
 - delivered prematurely at 26 weeks
 - 2 months in incubator and on ventilator

Kate (age 22)
 - received toxic dose of theophylline at age 9
 - acute episode of seizures, unconsciousness & respiratory arrest

All 3 patients showed bilateral hippocampal damage on MRI

Slide 20

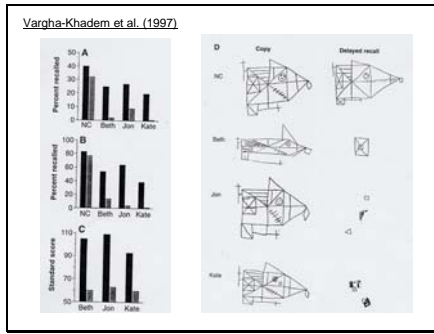

Slide 21

Vargha-Khadem et al. (1997)

	Beth	Jon	Kate
<i>Literacy (WORD) subtests</i>			
Basic reading			
Actual score	85	102	102
IQ predicted score	83	106	89
Spelling			
Actual score	77	84*	99
IQ predicted score	85	105	89
Reading comprehension†			
Actual score	84	97	88
IQ predicted score	81	107	87
<i>WISC-III and WAIS-R subtests</i>			
Information‡	9	10	6
Vocabulary§	7	14	8
Comprehension	7	11	7

Slide 22

Amnesic Syndrome

1. Anterograde amnesia
2. Preserved short-term memory
3. Preserved procedural memory
- motor, perceptual & cognitive skills
4. Preserved priming
5. Preserved semantic memory

Slide 23

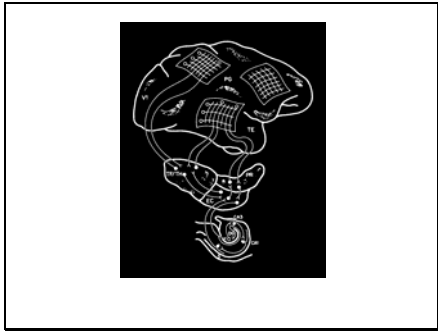

Slide 24

Retrograde Amnesia

The inability to remember events that occurred before the onset of the disease.

Slide 25

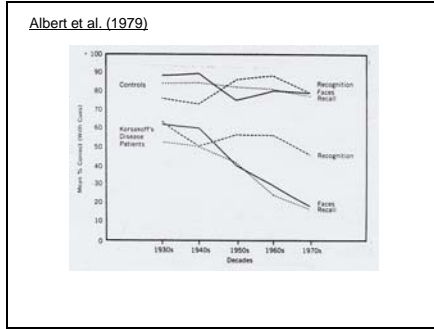

Slide 26

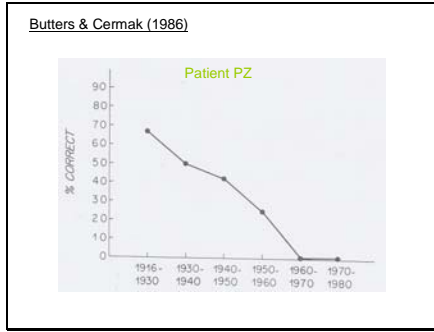

Slide 27

- Amnesic Syndrome
1. Anterograde amnesia
 2. Preserved short-term memory
 3. Preserved procedural memory
- motor, perceptual & cognitive skills
 4. Preserved priming
 5. Preserved semantic memory
 6. Temporally graded retrograde amnesia

Slide 28

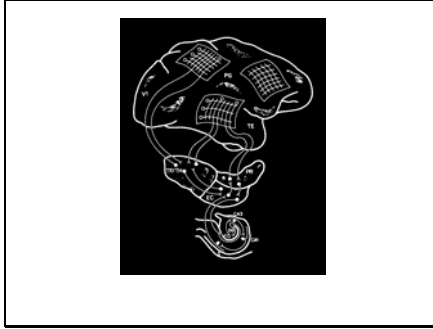

Slide 29

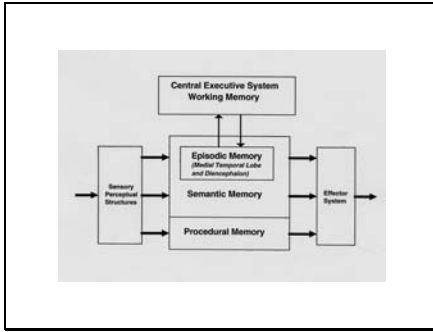

Slide 30

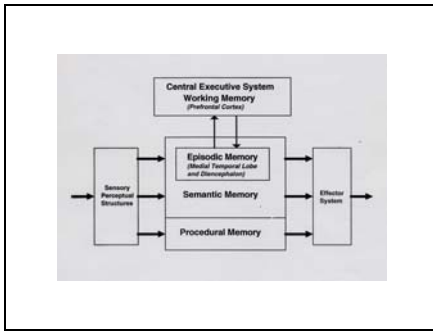

Slide 31

Frontal Lobe Amnesia
Retrieval Strategies
Temporal Ordering
Source Memory
Metamemory

Slide 32

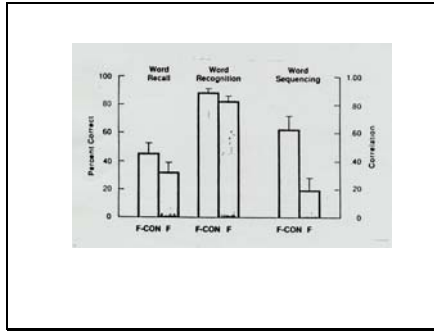

Slide 33

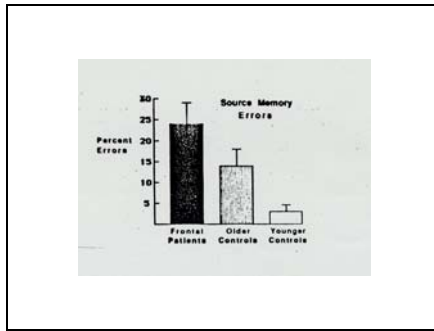

Slide 34

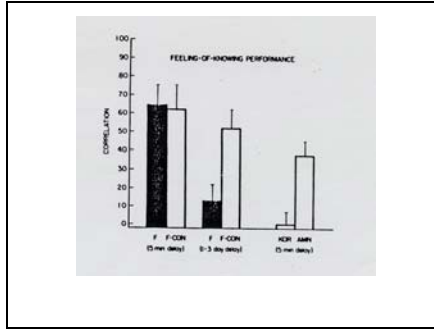

Slide 35

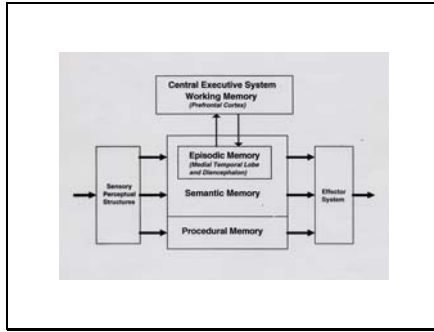

Slide 36

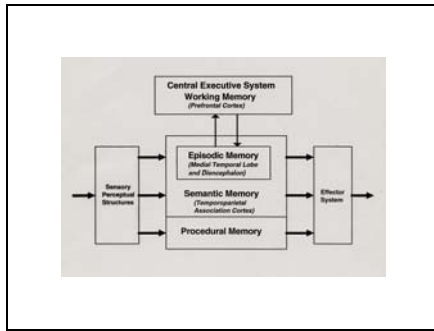

Slide 37

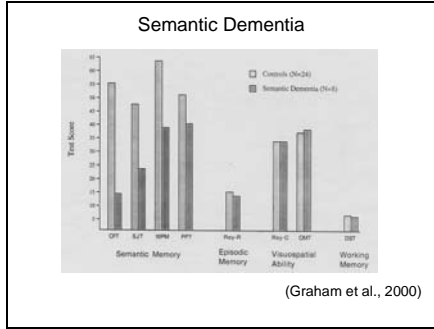

Slide 38

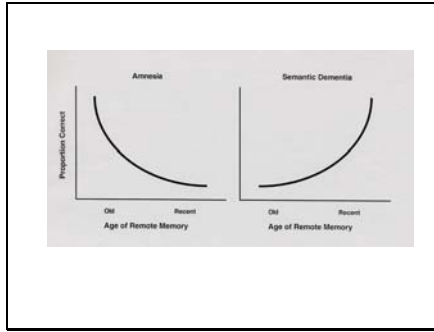

Slide 39

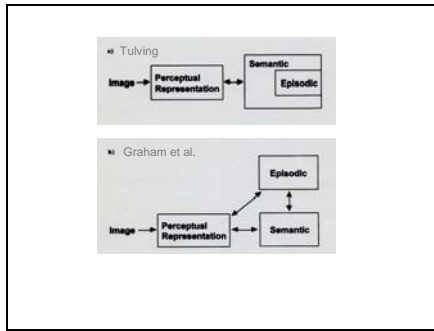

Slide 40

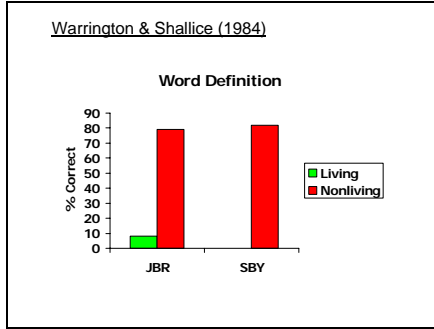

Slide 41

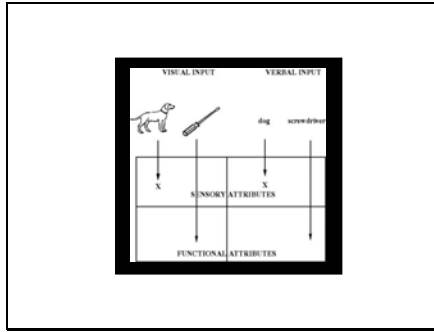

Slide 42

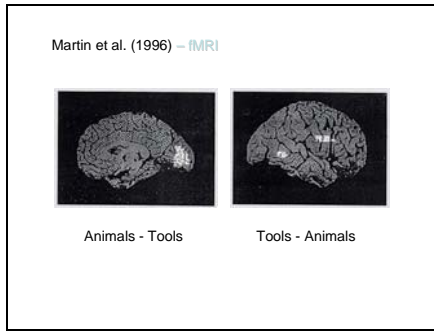

Slide 43

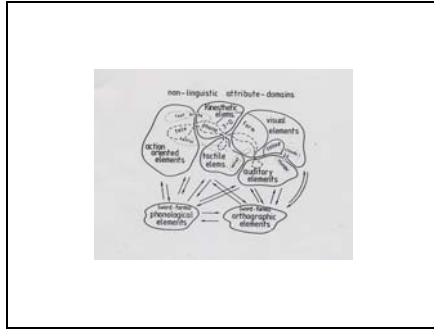

Slide 44

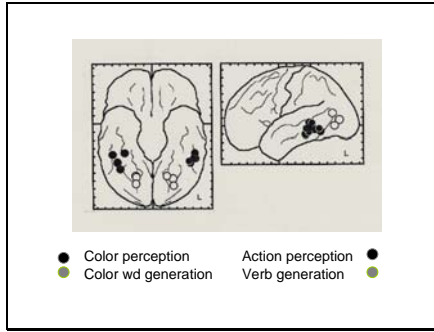

Slide 45

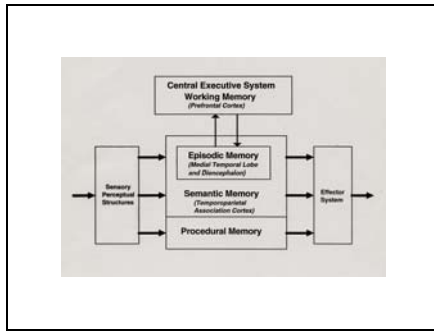

Slide 46

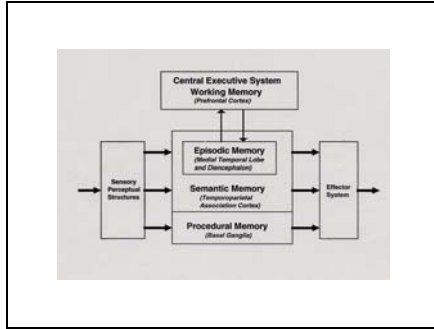

Slide 47

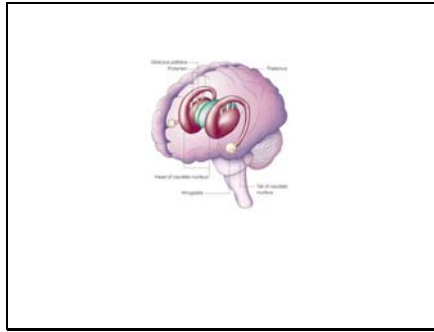

Slide 48

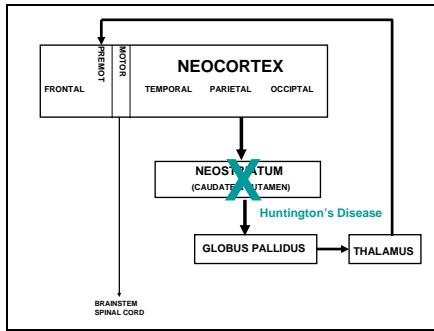

Slide 49

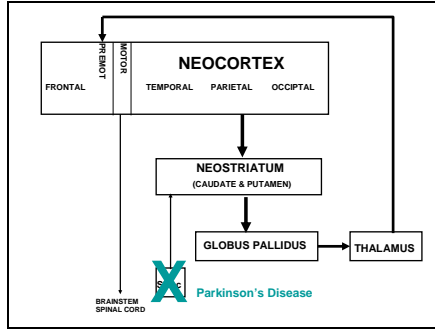

Slide 50

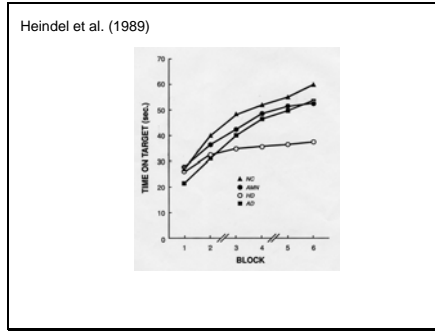

Slide 51

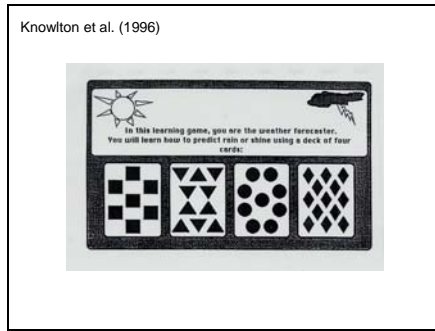

Slide 52

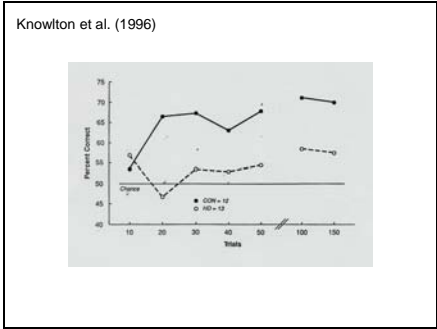

Slide 53

